

USER INSTRUCTION MANUAL

WASHING MACHINE WMUK002W



Galanz

Galanz (UK) Ltd
www.galanz.co.uk

Galanz

Please read this manual carefully before use and keep it for further reference

PREFACE

This washing machine conforms to current safety requirements. Inappropriate use can, however, lead to personal injury and damage to property. To avoid the risk of accidents and damage to the washing machine, please read this manual carefully before using it for the first time. It contains important information on the installation, safety, use and maintenance of the appliance. Keep this manual in a safe place for future reference.

Contents

Safety notices	1
Parts and features	3
Installation	4
The functions of the control panel	7
How to use washer	9
Cleaning and maintenance	12
Troubleshooting guide	14
Technical parameters	15
Electric Diagram	16

Safety Notices

Before Use

WARNING

Please ensure you read and understand these safety instructions thoroughly before use. The information contains important safety precautions, which must be followed. We cannot be held liable for damage caused by non-compliance with the warning and safety instructions or resulting from incorrect use or operation.



Cleaning and user maintenance shall not be carried out by children without supervision. Children less than 3 years old should be kept away unless continuously supervised. Only use the new hose-sets supplied with the appliance. Old hose-sets should not be reused.

This appliance is not intended for use by persons (including children) with reduced physical, sensory or mental capabilities, or lack of experience and knowledge, unless they have been given supervision or instruction concerning use of the appliance by a person responsible for their safety. Children should be supervised to ensure that they do not play with the appliance.

This appliance is intended for household use only. Any commercial use of this appliance will void the manufacturers warranty.

For washing machines having ventilation openings on the base, the washing machines cannot be washing on the carpet.

- Before installing the washing machine, check it for any externally visible damage. Do not install or use a damaged washing machine .
 - Before connecting the washing machine, ensure that the connection data on the plate (voltage and current) match the electricity supply. If in any doubt, consult a qualified electrician.
 - The electrical safety of this washing machine can only be guaranteed when continuity is complete between the appliance and an effective earthing system which complies with current local and national safety regulations. It is important that this basic safety requirement is present and regularly tested, and where there is any doubt the household wiring system should be inspected by a qualified electrician. The manufacturer cannot be held liable for the consequences of an inadequate earthing system. Do not connect the washing machine to the mains electricity supply
 - by an extension lead. Extension leads do not guarantee the required safety of the appliance. Unauthorised repairs could result in unforeseen dangers for the user,
 - for which the manufacturer cannot accept liability. Repairs should only be undertaken by an approved service technician. Ensure an electrical current is not supplied to the machine until after maintenance or repair work has been carried out.
- If the connection cable is damaged or broken, it must only be replaced by an approved service technician to protect the user from danger.
- Faulty components must only be replaced by genuine manufacturer original spare parts. Only when these parts are fitted can the safety standards of the machine be guaranteed.

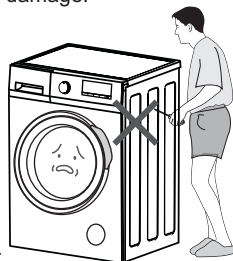

THIS WASHING MACHINE MUST BE EARTHED.

Safety Notices

Before Use

Correct use

- To avoid the risk of personal injury or damage to the washing machine, do not install it in a place that it is damp or at risk from rainfall.
- Do not install the washing machine in direct sunlight, to avoid plastic or components becoming damaged and shortening the life of your washing machine.
- Do not install the washing machine in places where temperatures may drop below freezing. Frozen hoses may burst or split and the reliability of the electronic control unit may be impaired.
- Keep the washing machine away from fire or heat sources.
- Before using the washing machine for the first time, check that the transit bolts at the rear of the machine have been removed. During the spin cycle, transit bolts which are still in place may damage both the machine and adjacent furniture or appliances.
- Turn off the water supply if the machine is to be left for any length of time (e.g. holiday), especially if there is no floor drain in the immediate vicinity.
- Take care to ensure that foreign objects (e.g. nails, pins, coins, paper clips) do not find their way into the machine with the laundry. These may damage components of the machine (e.g. drum), which in turn can result in damage to the laundry.
- Do not wash water-repellent clothing such as raincoats in the washing machine.

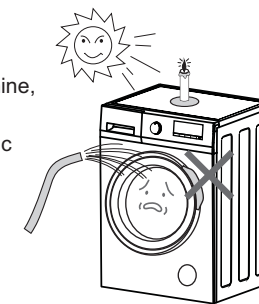

Child Safety

- Keep children away from the washing machine at all times. To avoid the risk of injury do not allow children to play on or near the appliance or to play with its controls.
- Older children may only use the washing machine if its operation has been clearly explained to them and they are able to use it safely, recognising the dangers of misuse.
- Remember that the door glass will be hot when washing at very high temperatures Please take care when touching the door.

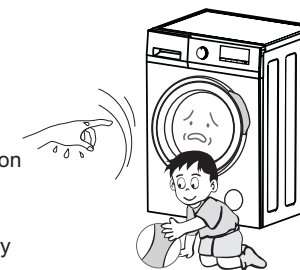

Parts and Features

Before Use

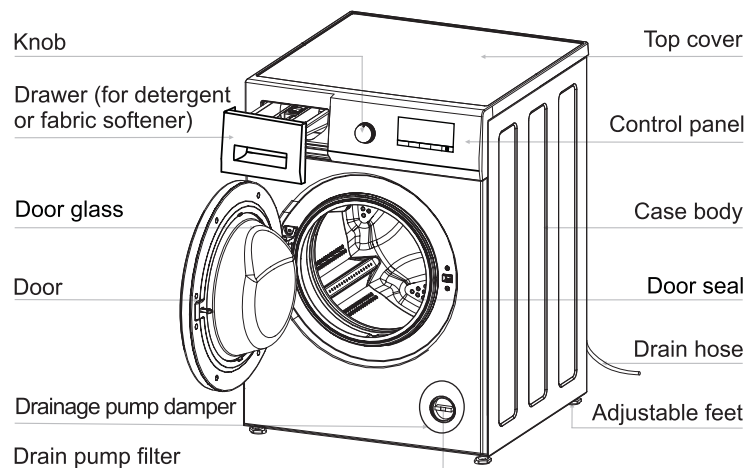

Note Unscrew the drain pump filter to let water run out when the machine is not used for a long time.

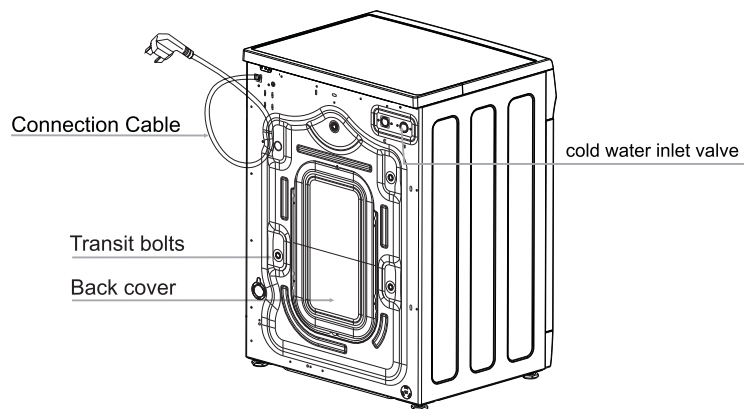

Note The drawing of machine in the manual is only used for instruction. It may be vary from the mode you buy.

Installation

Before Use

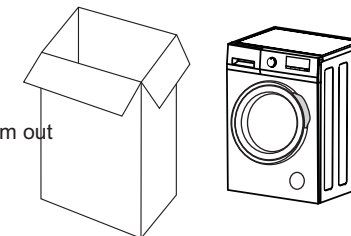

Backout packing

- Remove all the packing (including the foam base) otherwise vibration and noise may occur.
- Dispose off all the packaging material safely and keep them out of the reach of children. Danger of suffocation!
- It is normal that water drops may appear on the packing plastic bag and the door glass.

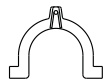

Accessories

Ensure that you have received all of the items shown below.

Accessories	Name	Qty.	Accessories	Name	Qty.
	Inlet hose	1		"U" piece	1
	transit bolts caps	4		Manual	1

Removing transit bolts

- Remove all the transit bolts located at the back of the machine using an appropriate tool.
- Plug the holes with the transit bolts caps supplied.



Note Strong vibration, noise or failures may occur if the transit bolts are not removed.

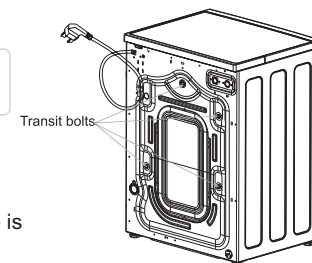

- Retain the transit bolts for future use. Whenever the appliance is transported, the transit bolts must be refitted.

Installation

Use process

Siting

- A concrete floor is the most suitable installation surface for a washing machine, as it is far less prone to vibration during the spin cycle than wooden floorboards or carpeted surfaces.
- The machine must be level and securely positioned. The distance between the machine and wall must be more than 10 cm.
- To avoid vibrations during spinning, the machine should not be installed on soft floor coverings.

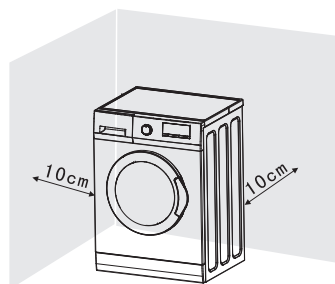

Level adjustment

The machine must stand perfectly level on all four feet to ensure safe and proper operation. Incorrect installation may increase electricity and water consumption and may cause the machine to move about.

To level the machine:

- Use a spanner to turn the locknut in a clockwise direction. Then turn locknuts together with adjust feet to unscrew.
- Use a spirit level to check the machine is standing level.
- Hold adjust feet securely with a pipe wrench. Turn locknut again using the spanner until it sits firmly up against the housing.

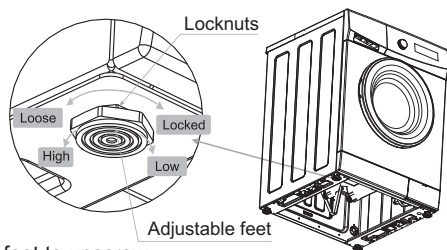

Note Vibration and noise may occur if the locknuts do not sit firmly up against the housing.

Drain hose connection

1. Direct to sink

If the outlet spigot has not been used before, remove any blanking plug that may be in place. Push the drain hose onto the spigot and secure with a clip if required, ensure a loop is formed in the drain hose to prevent waste from the sink entering the washing machine. If required, the drain hose can be extended to a length of 4 m.

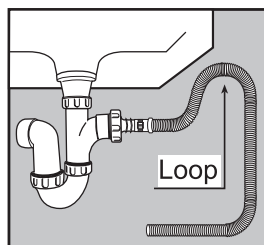
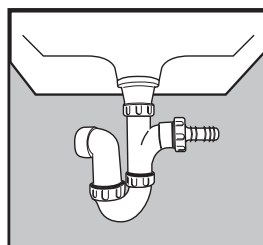

Installation

Use process

2. Connected securely to a standpipe

Firstly form a hook in the end of the drain hose using the "U" piece supplied. Place the drain hose into your standpipe, which should have an internal diameter of approximately 30mm thus ensuring there is an air break between the drain hose and standpipe. When discharging into a standpipe ensure that the top of the standpipe is no more than 90cm and no less than 60cm above floor level.

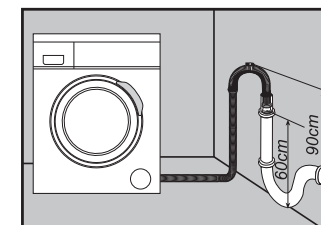
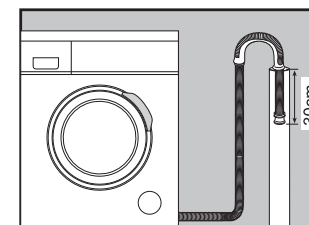
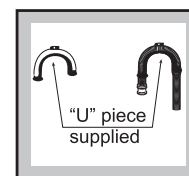

Water inlet connection

Connect the inlet hose supplied with the machine to a tap with a 3/4" thread. Do not use existing hoses.

Installation should comply with local water authority and building regulations' requirements.

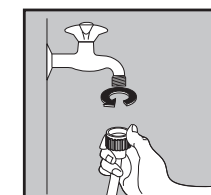
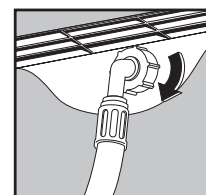

When there is an inlet valve at the back of the machine, it must be connected to a cold water supply. If there are two inlet valves, one should be connected to a cold water supply and the other connected to a hot water supply. Follow the picture below to complete the connection.

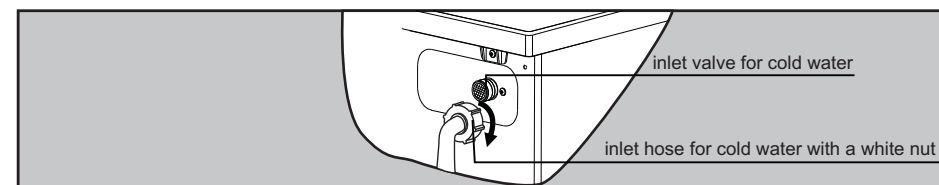

The functions of the control panel

Use process

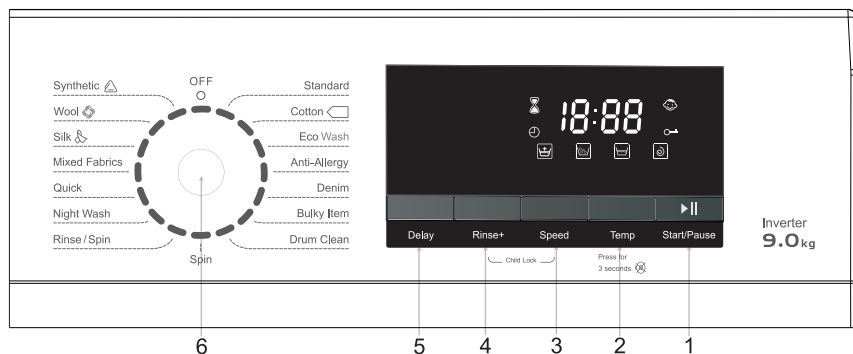

1.Start/pause (▶||)

Press this button to start or pause a wash cycle. The door cannot be opened when the machine pauses.

2.Temp

Press this button repeatedly to change the wash temperature. Full details can be found on page 8

3.Speed

Press this button repeatedly to change the spin speed. Full details can be found on page 8

4.Rinse+

Press this button repeatedly to change the rinse times. Full details can be found on page 8

5.Delay

Press this button repeatedly to set the delay time of the start of a wash cycle from 1 hour to 24 hours.

6.Knob

Turn this knob clockwise or anticlockwise to select the required wash programme. Once the "Start/Pause" button is pressed and the machine is running, the programme cannot be changed. Full details of programmes can be found on page 8.(Note: At the end of a wash cycle, the knob must be turned to the position "o")



Note For your safety, please do not turn the knob to the position "o" to remove clothes while the machine is running as the temperature of water may be high and it may scald you. The door lock will open automatically at the end of a wash cycle while the temperature of the drum is cooling down.

• Child lock ("Rinse+ " + "Speed")

The function of "Child lock" is to lock the control panel to prevent the misuse by children .

1.Press the "Rinse+" and "Speed" buttons simultaneously for 3 seconds.

When the icon "👶" is lit up on the screen, the function is activated. This function can be selected during a washing cycle.

2.When this function is activated, all keys and knobs are unavailable, except for the knob turn to the position "o"

• Mute ("Temp ")

The function of "Mute" is to close all the prompt tones and alert sounds.

To activate this function: Press the "Temp" button for 3 seconds.

How to cancel this function: Press the "Temp" button for 3 seconds again.

The functions of the control panel

Use process

Options and functions for programmes

Programme	Weight (kg)	Time (min)	Temp (°C)	Rinse times	Spin speed(rpm)	Delay
Standard	9	76	00/20/40/60/95	2	0/400/600/800/1000/1200/1400	●
Cotton	9	287	00/20/40/60/95	2	0/400/600/800/1000/1200/1400	●
Eco Wash	6.5	49	20	2	0/400/600/800/1000/1200	●
Anti-Allergy	5	131	95	2	0/400/600/800/1000	●
Denim	5	100	00/20/40	4	0/400/600/800	●
Bulky Item	9	99	00/20/40/60	3	0/400/600/800	●
Drum Clean	0	74	60/95	2	800	●
Spin	9	11	---	0	0/400/600/800/1000/1200/1400	●
Rinse/Spin	9	16	---	1	0/400/600/800/1000/1200/1400	●
Night Wash	7	81	00/20/40/60	5	0/400/600/800	●
Quick	3	18	00	2	0/400/600/800/1000/1200	●
Mixed Fabrics	5	63	00/20/40/60	3	0/400/600/800/1000/1200/1400	●
Silk	3.5	48	00/20/40	2	0/400/600	●
Wool	3.5	50	00/20/40	2	0/400/600	●
Synthetic	4.5	51	00/20/40/60	2	0/400/600/800	●

Display icon explanation

18:88	Digital display: This icon shows the time, speed, rinse times, Error code.
🕒	Remaining time: This icon will display the remaining time of the cycle.
🕒	Delay time: This icon indicates that the delay time function is active.
👶	Child lock: This icon indicates that the child lock function is selected
🔑	Door lock: This icon indicates that the door is locked.
👑	Rinse+: This icon indicates that the rinse+ function is selected.
👕	Main wash: This icon will be bright in standby mode. When selected with the main wash function the icon will flicker when the machine is in operation. The icon will be bright in pause mode and extinguish when the machine finishes its cycle
👕	Rinse: This icon will be bright in standby mode. When selected with the rinse function the icon will flicker when the machine is in operation. The icon will be bright in pause mode and extinguish when the machine finishes its cycle
🌀	Final spin: This icon will be bright in standby mode. When selected with the final spin function the icon will flicker when the machine is in operation. The icon will be bright in pause mode and extinguish when the machine finishes its cycle



Note When the "Night Wash" programme, the machine will not execute the last drain unless the "Start/Pause" button is pressed, and the screen show "Iron". (Note: the max running time of this function is 12 hours . If it exceeds 12 hours, the machine will drain and spin automatically).

How to use the washer

Use process

Before washing clothes for the first time, you must run a complete cycle without clothes.

To do this:

1. Connect the power and turn on the tap.
2. Turn the knob to position "Standard".
3. Press "Start/Pause".

This will remove any water remaining in the tub from the manufacturers testing process.

Washing preparation

1. Connect the inlet hoses well and turn on the tap.
2. Ensure the power socket is grounded correctly, insert the power plug into the power socket.
3. Position the drain hose appropriately.

Preparation of clothes

1. Sort the laundry by colour and by care label. Most garments have a textile care label in the collar or side seam.
2. Ensure all pockets are empty. Foreign objects (e.g. nails, coins, paper clips, etc.) can cause damage to garments and components in the machine.
3. Close any zips and fasten hooks and eyes etc before washing.
4. Dark textiles often contain excess dye and should be washed separately several times before being included in a mixed load. Always wash whites and coloureds separately.
5. Badly soiled areas, stains etc. should be pre-treated with liquid detergent, stain removers etc.
6. Wash clothes which pill easily inside out.

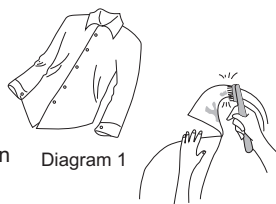

Diagram 1

Diagram 2



Diagram 3

Put clothes into the washer

Unfold the laundry and load loosely into the drum. Mixing both large and small items gives better wash results and helps distribute the load evenly during spinning. The most efficient use of energy and water is achieved when a full load is washed. However, do not overload as this causes creases and reduces cleaning efficiency.



Note Make sure that no garments are caught between the door and the seal.

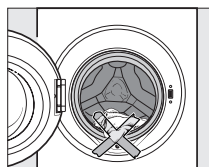

How to use the washer

Use process

Using the detergent drawer

1. Open the drawer and add adequate detergent into the main wash compartment marked "III" or "II".
2. Add fabric softener into the compartment marked "II" or "I".
Do not exceed the maximum level mark.
3. Add the detergent into the pre-wash compartment marked "I" or "I" according to the programme you select.
4. Close the drawer.

The right amount to dispenser will depend on the following:

- The quantity of laundry
 - Lightly soiled
No visible dirt or stains. Possibly slight body odour.
 - Normally soiled
Visibly dirty and/or just a few slight stains.
 - Heavily soiled
Visible dirt and stains and/or dried on soiling.
- The water hardness level.

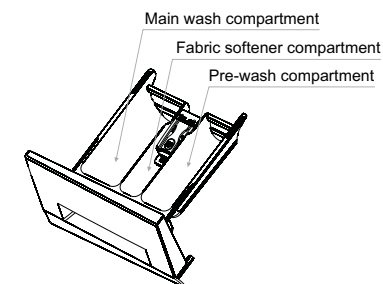

Note It is recommended to use low foaming powder for all washing temperature programmes.

Washing steps

1. Turn on the water tap, and connect the power.
2. Open the door, and load the clothes into the drum one by one.
3. Close the door, and put suitable amount of detergent and fabric softener into the dispenser.
Close the drawer.
4. Choose the desired programme by turning the knob.
5. Press the "Temp" button and select a washing temperature.
6. Press "Start/Pause" button to start the washing machine.
7. When the cycle is finished, the warning tone sounds (If activated)



Note When the washing cycle is finished, the machine will change into standby mode. If there is no further use for 10 minutes, the machine will automatically go into sleep mode

How to use the washer

Use process

Washing programme chart

Programme	Washing symbol	Fabric
Standard		Cottons, linens or cotton mix fabrics, e.g. table linen, towelling, underwear, T-shirts etc.
Quick		Small loads of items which require freshening up and which can be washed on a Cotton programme.
Rinse+Spin		This programme can be used for rinsing items which can be washed on a Cotton programme. Do not add any detergent.
Spin		Separate spin for cotton and linen items
Cotton		Cottons, linens or cotton mix fabrics, e.g. table linen, towelling, underwear, T-shirts etc.
Synthetic		Synthetic or mixed fabrics, underwear, coloured garments, non-shrink shirts
Wool		Machine-washable or hand-washable wool or wool blend fabrics. If the care label does not specify a temperature, wash using the cold setting. Also suitable for hand-washable silks. Reduce the spin speed.



Note

The machine is fitted with a balance control device, which ensures the machine is stable during the spin. To protect the machine, it will cut in if the laundry is not evenly distributed in the drum. The laundry is redistributed by reverse rotation of the drum. This may happen several times before the unbalance disappears and normal spinning can resume. If, after 15 minutes, the laundry is still not evenly distributed in the drum, the machine will not spin. In this case, redistribute the load manually and reselect the spin programme.

Door lock

- The door lock is activated once the "Start/Pause" button is pressed. Turn the knob to position "O" and the door lock is deactivated after two minutes.
- When the temperature inside the drum is above 60°C, the door lock is locked.
- When the water is above a certain level, the door lock is locked.
- When the washing cycle is finished, the door lock is unlocked after two minutes.

Important:

Do not try to open the door when the washing cycle has not finished or the power supply is cut off during the washing cycle, as the temperature may be high and you may be scalded.

Cleaning and Maintenance

Use process



Disconnect the machine from the mains electricity supply and withdraw the plug from the socket before cleaning the machine.



The washing machine must not be hosed down.

Cleaning the exterior

Clean the exterior with a mild non-abrasive cleaning agent or soap and water using a damp cloth. Wipe dry with a soft cloth.



Do not use solvents, abrasive cleaners, glass cleaners or all-purpose cleaning agents. These might damage plastic surfaces and other components because of the chemicals they contain.

The washing drum

Clean the drum every 3 months by using the "Drum clean" programme.

Cleaning the drawer

Remove detergent residues regularly. Clean the drawer as follows:

- Pull out the drawer until a resistance is felt. Press down the release catch and pull the drawer out of the machine.
- Remove the siphon from compartment and clean it.
- Clean the dispenser using a brush and warm water.

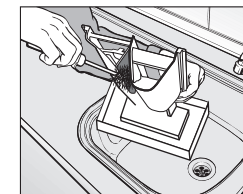
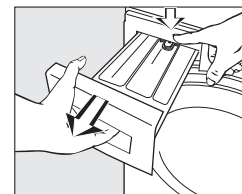

Cleaning and Maintenance

After use

Cleaning the drawer housing

Use a bottle brush to remove detergent residues inside the drawer housing.

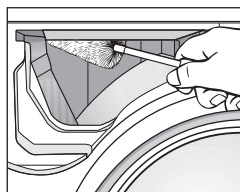

Cleaning the water inlet filter

Use pointed nose pliers to withdraw the plastic filter. Clean, put back and secure. These filters should be checked every 6 months or so, or more often if there are frequent interruptions to the water supply.

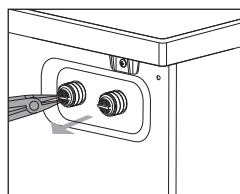

The filter must be put back in place after cleaning.

Cleaning the drain pump filter

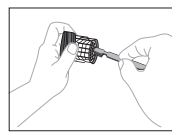
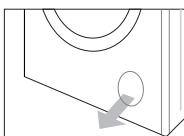

1. Disconnect the machine from the mains electricity supply and open the lower cover with a screwdriver.
2. Place a container under the pump. Unscrew and remove the filter.
3. Clean the filter carefully.



The filter should be cleaned every 2 months or when the fault "E03" is displayed on the screen.

Important:

If the machine is exposed to temperatures below 0°C, certain precautions should be taken.

1. Turn off the water tap.
2. Unscrew the inlet hose.
3. Unhook the drain hose from the rear support and place the end of this hose and the inlet hose in a bowl. Run the spin programme.
4. Disconnect the appliance.
5. Screw the inlet hose and reposition the drain hose.
6. When you intend to start the machine up again, make sure that the room temperature is above 0°C.

Troubleshooting guide

Difficult explanation

Problem	Error Code	Possible Cause	Solutions
The machine fills overtime.	"E01"	<ol style="list-style-type: none"> 1. Water tap is not open. 2. Drain hose is too low. 3. Water inlet valve is damaged. 	<ol style="list-style-type: none"> 1. Open the water tap. 2. Hook up the hose. 3. Change the water inlet valve.
Door lock alarm sounds	"E02"	<ol style="list-style-type: none"> 1. The door is not locked properly. 2. Garment is caught between the door and seal. 3. Door lock is damaged 	<ol style="list-style-type: none"> 1. Ensure the door is fully closed. 2. Put the garment into the drum. 3. Change the door lock.
The machine drains overtime.	"E03"	<ol style="list-style-type: none"> 1. The drain hose is squashed or kinked. 2. The drain pump filter is blocked. 3. The drainage system pipes are blocked. 	<ol style="list-style-type: none"> 1. Check the drain hose. 2. Clean the filter. 3. Check the drainage system and clean it.
Water overflow. Water sensor works abnormally.	"E04"	<ol style="list-style-type: none"> 1. The water inlet valve is damaged. 2. The connection between the water sensor and wire is not secure. 3. The water sensor is damaged. 	<ol style="list-style-type: none"> 1. Change the water inlet. 2. Check the connection is secure. 3. Change the water sensor.
The motor does not work.	"E05"	<ol style="list-style-type: none"> 1. The connection between the motor and wire is not secure. 2. The motor has over-heated. 3. The motor is damaged. 	<ol style="list-style-type: none"> 1. Check the connection is secure. 2. Check if the machine is overloaded. Switch off the machine, and retry when the motor has cooled down. 3. Change the motor.
Heating tube fault.	"E06"	<ol style="list-style-type: none"> 1. The connection between the heating tube and wire is not secure. 2. The heating tube is damaged. 	<ol style="list-style-type: none"> 1. Check the connection is secure. 2. Change the heating tube.
Temperature sensor fault.	"E07"	<ol style="list-style-type: none"> 1. The connection between the temperature sensor and wire is not secure. 2. The temperature sensor is damaged. 	<ol style="list-style-type: none"> 1. Check the connection and ensure it is secure. 2. Change the temperature sensor.

Technical Parameters

Appendix

Parameter	Model	WMUK002W
Power		220V-240V~.50HZ
Washing / spin capacity		9.0kg
Rated power		2000W
Water pressure		0.02-0.8MPa
Power of off-mode		0.42W
Power of left-on mode		0.42W
Program time(min)		302
Remaining moisture content		Class B
Average Energy consumption		0.97kWh
Average Water consumption		53L
Net weight / gross weight		66kg/71kg
Outer dimension (W x D x H)mm		595X545X845mm

Note:
 Data can vary from the nominal values given depending on water pressure, water hardness, water inlet temperature, room temperature, type and volume of load, fluctuations in the electricity supply and any extra options selected.

Electric Diagram

Appendix

